

Microair Avionics



M760 TRANSCEIVER INSTALL & USER MANUAL



Microair Avionics Pty Ltd

Airport Drive
Bundaberg
Queensland 4670
Australia

Tel: +61 7 41 553048

Fax: +61 7 41 553049

e-mail: sales@microair.com.au

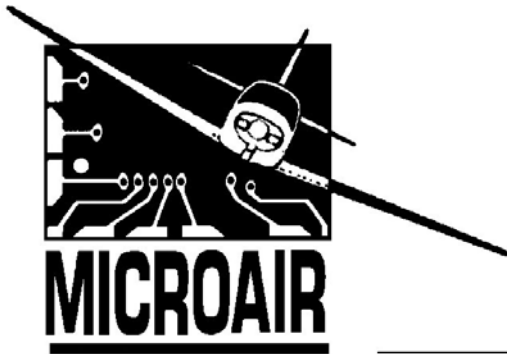

About This Document

This manual describes the various installation configurations available for the Microair M760 Transceiver. The Transceiver's controls and design features are described and illustrated.

Microair reserves the right to amend this manual as required, to reflect any enhancements or upgrades to the M760 Transceiver.

© Microair Avionics Pty Ltd

Ensure that the M760 transceiver is switched off during engine starting and stopping to avoid damage occurring.



CURRENT REVISION STATUS

Revision	Date	Change
K	31/01/00	Initial release
L	18/11/01	Additional install data and wiring diagram added
M	04/10/02	Additional wiring diagram added
N	08/12/03	Updated for revision N
P	01/10/06	Updated for revision P
01R3	13/10/06	Updated for proposed functionality of revision P
01R4	30/05/07	Proposed functionality for revision P amended
01R5	28/06/07	Updated for functionality as of M760_MICRO_1-3-3
01R6	3/06/08	Warranty Statement Upgrade
01R7	08/12/08	Updated for revision P2
01R8	25/2/09	Updated Limited Warranty Statement & deleted Warranty cards
01R9	24/4/09	repair@microair.com.au added to Warranty Statement

TABLE OF CONTENTS

1.0	INTRODUCTION.....	4
2.0	UNPACKING	4
2.1	USER / INSTALL MANUAL	4
2.2	AUTHORISED RELEASE CERTIFICATE.....	4
3.0	DESCRIPTION	5
4.0	INSTALLATION	6
4.1	ELECTRICAL INSTALLATION.....	7
4.2	COAX TERMINATION	8
4.3	ANTENNA	8
4.3.1	METAL SKIN AIRFRAMES	8
4.3.2	NON-METAL SKIN AIRFRAMES	8
4.4	POWER.....	9
4.4.1	BACKLIGHTING	9
4.4.2	POWER SAVINGS	9
4.4.3	POWER FILTER.....	9
4.5	MICROPHONE	10
4.5.1	ELECTRET.....	10
4.5.2	DYNAMIC	10
4.6	SPEAKER	10
4.7	INTERNAL VOX INTERCOM.....	11
4.8	HEADSET ADJUSTMENT.....	11
4.8.1	SIDETONE.....	11
4.8.2	MIC GAIN.....	11
4.8.3	TRIMPOT ADJUSTMENT.....	11
4.9	EXTERNAL INTERCOM	12
4.10	DUAL COMM INSTALLATION	12
5.0	OPERATIONAL CONTROLS.....	13
5.1	PRIORITY SWITCH	14
5.2	VOLUME / SQUELCH KNOB	14
5.3	ANNUNCIATOR LED.....	14
5.4	MODE SWITCH.....	15
5.5	FREQUENCY ADJUST KNOB	15
5.6	TOGGLE SWITCH.....	16
5.7	REMOTE MEMORY BUTTON	16
5.8	PUSH TO TALK BUTTON.....	16
6.0	MODES	17
6.1	ACTIVE/STANDBY MODE.....	17
6.1.1	108 TO 118 MHZ	17
6.1.2	MONITOR FUNCTION.....	18
6.2	CHANNEL MODE	19
6.3	VOX MODE	19
7.0	PROGRAMMING & SETUP	20
7.1	CD LOCKOUT	20
7.2	VOX.....	21
7.3	MONITOR SETUP	21
7.4	NEW MEMORY MODE	22
7.5	EDIT MEMORY MODE	22
7.6	EXIT MENU	23
8.0	WIRING DIAGRAM.....	24
9.0	SPECIFICATIONS M760 P2.....	25
10.0	DRILLING TEMPLATE	26
11.0	LIMITED WARRANTY	27

1.0 INTRODUCTION

Thank you for purchasing this Microair product. The M760 is a 760 channel VHF aircraft transceiver, packaged to fit a standard 57mm (2 ¼") instrument hole. The M760 has been produced in accordance with CASA APMA approval E2000-004.

2.0 UNPACKING

The M760 is boxed in polystyrene for physical protection, and wrapped in an anti-static bag for electrical protection. Once the box is opened and the radio unwrapped, the owner is responsible for physical and electrical protection.

Enclosed with the radio are: User / Install Manual
CASA form 1 – release certificate
DB15 solder plug and backshell

2.1 USER / INSTALL MANUAL

Please read this manual completely before attempting to install or operate this radio. There are several installation options you may wish to consider, which are clearly laid out in the installation section.

The M760 has all of the basic radio operations, and many other management and programming options, which are described in the operation and memory sections of this manual.

Please refer to the Microair Avionics Website www.microair.com.au for more installation information.

2.2 AUTHORISED RELEASE CERTIFICATE

The CASA form 1 – release note is an internationally recognised document which clearly identifies the part/component the form 1 is associated with. Please keep this certificate with the aircraft's file or log book.

3.0 DESCRIPTION

The M760 VHF Transceiver has a 57mm (2 1/4”) round face to fit a standard small instrument hole. The case is 59mm high x 65mm wide x 135mm long.



Front Face

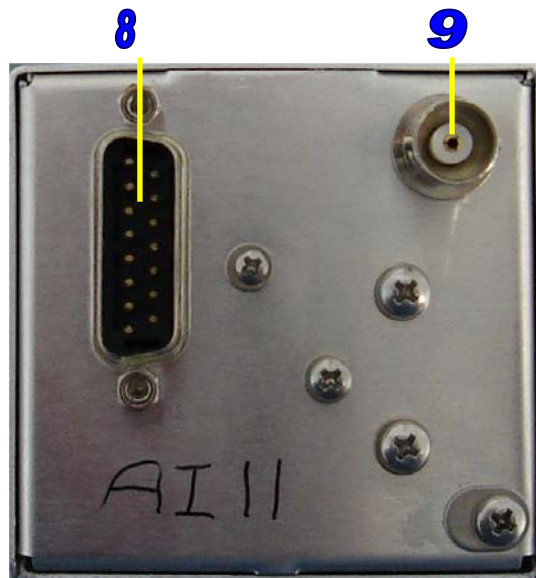

Rear Face

ITEM	CONTROL	DESCRIPTION
1	M4 x 12 Pan Phillips	Mounting screw
2	Priority Switch	Momentary push down switch
3	Volume / On / Squelch	Click On - Rotate knob for volume Rotate ring for squelch
4	Receiver / Transmit Annunciator	Red / Green LED
5	Mode Switch	Momentary push down switch
6	Frequency Adjust Knob	Rotate to adjust value Press to move cursor
7	Toggle Switch	Momentary push down switch
8	DB15 Connector	Push in fit with lock nuts
9	BNC Coaxial Connector	
10	LCD Display	Two lines of eight characters each

4.0 INSTALLATION

The M760 is very simple to physically install in an aircraft's instrument panel. Select or cut a 57mm (2 1/4") instrument hole for mounting. Present the M760 to the rear face of this hole. The stepped round face will insert through the hole, and should appear flush with the front of the instrument panel when correctly positioned. Rotate the M760 to align the four M4 machine screws.

For installations where the existing instrument panel screw holes are 1/8", the hole will need to be enlarged to 5/32" to fit the M4 machine screws.

Insert and tighten all four M4 machine screws. The M760 requires no rear support, the M4 screws provide all of the physical mounting required.

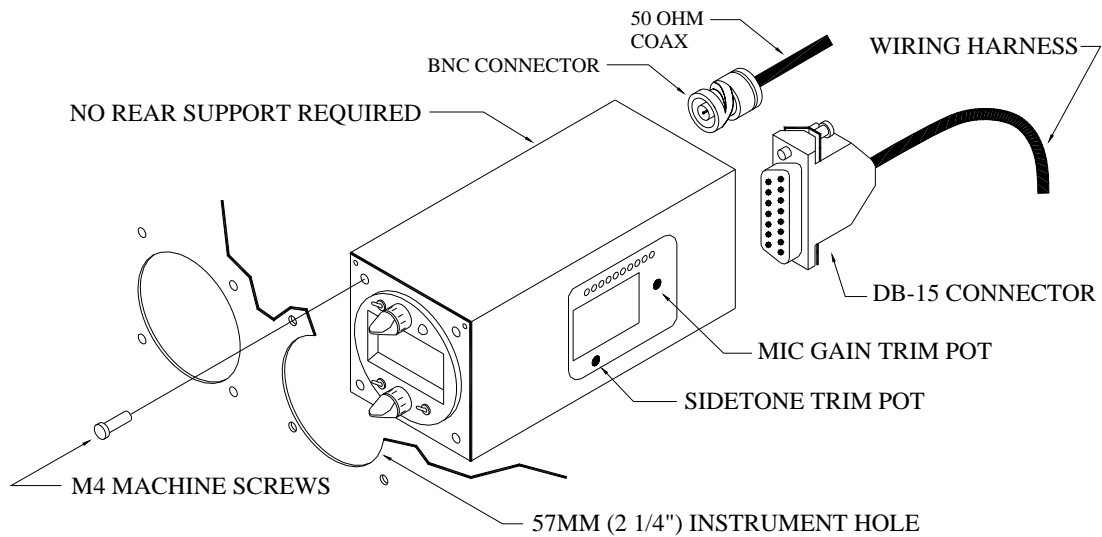

MICROAIR MA-760
PANEL INSTALLATION

The M760 should be located in the aircraft within view of the pilot seated in the pilot-in-command position, and afford this pilot good access to the front face controls.



Do NOT oversize the mounting holes in the front face of the radio, to an imperial size. Drilling will damage internal components.

Do NOT replace the M4 machine screws supplied with the radio with longer screws. Over-length screws will touch or even crush internal components and cause damage.

Either of these actions will void the warranty

4.1 ELECTRICAL INSTALLATION

Microair recommends the use of the wiring in the table below for the various parts of the radio harness:

Line	Wire
Power	Tefzel 22 awg wire (2 lines)
Ground	Tefzel 22 awg wire (2 lines)
PTT	Tefzel 22 awg wire
Memory	Tefzel 22 awg wire
Signal Ground	Tefzel 22 awg wire
Speaker	Tefzel 22 awg single core shielded
Microphone	Tefzel 22 awg single core shielded
Headphone	Tefzel 22 awg single core shielded
Aerial	RG58C/U 50 ohm Coaxial Cable

All wiring is connected by soldering to the DB15 connector.

Strip the insulation back 2mm (1/16”), and “tin” the exposed conductor with solder. Slide a 5mm length of 3.2mm (1/16”) heatshrink tubing over the end of the wire. After checking the wiring diagram for the correct pin number, push the “tinned” end into the terminal, and solder into place. Check the soldered joint has been made, by gently pulling on the wire. Slide the heatshrink tubing down over the soldered pin, to completely cover the conductor.



“Tinned” wire

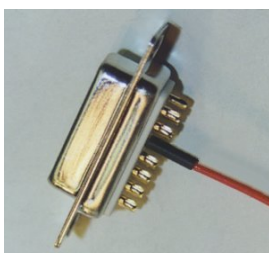

Soldered with heatshrink

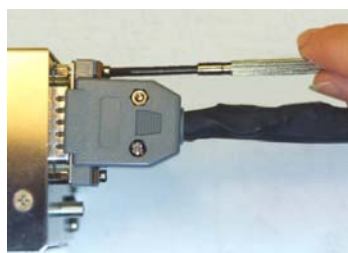

Locking bolts tightened

Cover the soldered joints with the grey plastic backshells. Ensure that the locking bolts are in place before closing the backshells. Connect to the rear of the radio with a push fit, and secure the locking bolts (top and bottom).

Microair recommends the use of its pre-wired M760 harness.

The harness is available from Microair, and comes complete with all switches, sockets, buttons, and mounting hardware.

Separate lines have been wired for Pilot and Co-pilot:

- Headphone
- Microphone
- PTT
- Remote Memory



4.2 COAX TERMINATION

The coax is cut to length and terminated in a BNC connector. Soldered or crimp type connectors are preferred to the solderless variety, as they have lower signal loss and better shielding.

Microair recommends using only soldered or crimped BNC connectors.

Solderless BNC connectors are NOT recommended, as their performance is not good enough for VHF transmissions.

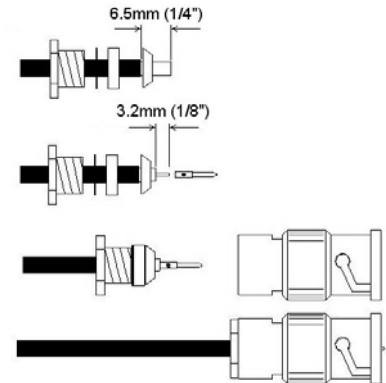

4.3 ANTENNA

For certified aircraft the M760 should only be operated with a TSO compliant antenna. The antenna may be ¼ wave whip or ½ wave dipole, using 50ohm coaxial cable and a BNC connector for connection. The VSWR should ideally be less than 2:1 across the 118.000MHz to 136.975MHz airband.

For non-certified aircraft using a non-TSO compliant antenna, the VSWR must be checked to ensure the ratio does NOT exceed 3:1 across the 118.000MHz to 136.975Mhz airband. The M760 will tolerate a VSWR of 5:1 without injury to the transceiver, but the performance is severely deteriorated.

Do not use the stubbie “rubber duckie” antennas meant for use with handheld radios.

4.3.1 Metal Skin Airframes

For metal skin aircraft a ¼ wave whip is the easiest antenna to fit. Ensure that the antenna base and the coax shield are firmly grounded to the skin of the airframe, on the inside of the aircraft. Ensure that any anti-corrosion product, which may be used to seal the exterior surface, does not isolate the antenna base from the airframe. For best performance the whip should be straight and vertical, when mounted on the airframe.

Refer to the Microair Avionics website www.microair.com.au for more detail on antennas suitable for metal skin airframes.

4.3.2 Non-Metal Skin Airframes

For non-metal airframes, a ¼ wave whip may still be used, but a ground plane must be installed, on the inside face of the aircraft skin. The ground plane should ideally be circular, and have a diameter of half the height of the whip. The ground plane should be fabricated from a lightweight metal, eg thin aluminium sheet, or adhesive foil tape. For best performance the ground plane should be flat and horizontal, when mounted on the airframe.

An alternative antenna for non-metal airframes is the Ground Plane independent dipole. This antenna is physically similar to the ¼ wave whip, but has a small stubbie antenna pointing downwards from the antenna base. The stubbie section of the antenna takes the place of the ground plane, and simplifies installation.

Beware of fabric surfaces with silver dope finishes. The silver dope is a conductive surface, and with screen antennas which are mounted internally.

Refer to the Microair Avionics website www.microair.com.au for more detail on antennas suitable for non-metal skin airframes.

4.4 POWER

The M760 is designed to operate on a 14V aircraft electrical supply. The radio will operate down to 10.7V on receive.



It is unlikely that a power supply operating below 11V would have sufficient power to allow clear transmissions.

The M760 will draw approx 1.6A when transmitting.

Low power will produce a BURRRRRRRRRR signal.

The maximum voltage for the M760 is 18V. **NEVER** operate the M760 on voltage exceeding 16V.



Damage will occur if the M760 is operated from power supplies which exceed 16V, even for very short (transient) periods.

Operation on a supply which exceeds 16V will void the warranty.

The M760 has a diode and internal fuse to protect against reverse polarity. If reverse polarity is applied the fuse (4A) will blow. Damage however may not be limited to the fuse.



Please ensure that the correct polarity is observed. The most common reason for reverse polarity, is misreading the pin assignments on the DB-15 connector.

Applying reverse polarity to the M760 will void the warranty

4.4.1 Backlighting

The backlighting is activated, by taking input supply voltage to pin 8. This line can be individually switched outside the DB15 connector to enable the backlighting to be turned off.

The power for the backlighting may be routed from a dimmer switch. The power must however be ultimately sourced from the avionics master switch, to ensure that all components of the M760 are off during start-up and shutdown of the engine.

4.4.2 Power Savings

For installations, operating from a battery only, Microair recommends saving battery power by **NOT** wiring the backlighting – do **NOT** wire pin 8. The backlighting will draw an additional 80mA of power. This nearly doubles the standby power demand.

Not connecting the backlighting can effectively double the running time on your battery.

The operator should remember that the minimum operating voltage is 10 volts. This is the **loaded** voltage (ie the voltage when the radio is transmitting). For battery operators, check the battery voltage level, then press the PTT briefly to note the voltage drop. If the voltage dips by more than 0.2 volts, change the battery before flying.

4.4.3 Power Filter

Microair recommends the installation of a power filter to supply power to the M760. A simple line filter is sufficient to ensure that the voltage is smooth, and causes no interference to the radio. If an engine noise can be heard, and it rises and falls with the RPM, install a power filter.

Refer to the Microair Avionics website www.microair.com.au for more information on aircraft electrical systems.

4.5 MICROPHONE

The M760 can be operated with an Electret Insert or Amplified Dynamic microphone. These alternatives cover most aviation headsets and hand microphones.

When the PTT is pressed both microphones are live. To reduce background noise, the M760 can be installed with relays across the mic lines and the PTT line, to allow only one microphone at a time to operate.

4.5.1 Electret

Electret microphones are the most common microphone in use on aviation headsets. They are small in size, and can have noise cancelling capability. It is important to wire the Electret microphone with the correct polarity. The Electret will only work if the positive and negative are wired correctly.

Electrets are a high signal device, and do not normally require amplification. Some headset manufacturers elect to use an amplifier to improve the Electret's response, and to provide some noise filtering.

4.5.2 Dynamic

Dynamic microphones are a low signal device. A dynamic microphone will not operate directly with an M760 radio, because of the low signal produced.

For operators wanting to use a dynamic microphone, a mic amplifier must be used. Microair recommends the installation of the Microair MD-01a amplifier. This amp is compatible with 150-600 ohm dynamic microphones.

Refer to the Microair Avionics website www.microair.com.au for further details on microphone types, and wiring configurations.

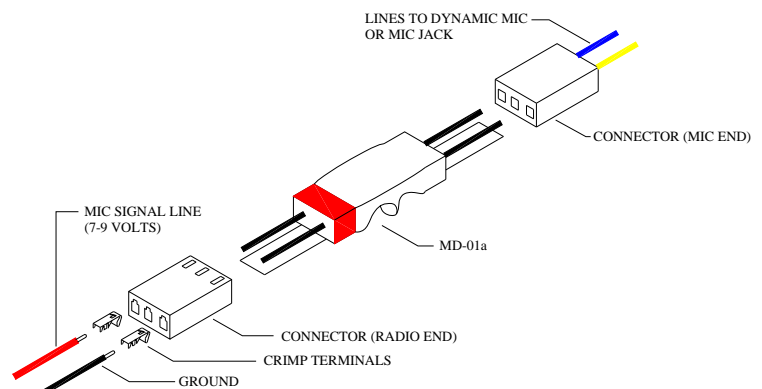

4.6 SPEAKER

Microair recommends using a speaker of 4 ohms impedance, rated at a minimum of 5 watts. The speaker is wired to the speaker line (pin 15). Do NOT attempt to connect a speaker to the headphone line (pin 14). Likewise do NOT attempt to connect the headphones to the speaker line.

Microair recommends the SP01 Box Speaker. The SP01 has a durable thick film plastic cone of 4 ohms, and is rated at 5 watts. The SP01 is fitted with a mounting bracket, and is supplied with clips and screws.

Check your speaker choice by ensuring the audio is clear up to at full volume.



4.7 INTERNAL VOX INTERCOM

The M760 is fitted with a VOX intercom feature which utilises the sidetone facility of the radio. The VOX threshold level is controlled in software by use of the Intercom Adjust Mode. See section 5.4 to adjust the internal VOX intercom.

4.8 HEADSET ADJUSTMENT

It is important to ensure that the sidetone and mic gain are set to the correct levels, for best headset performance. The sidetone level will set the VOX intercom volume. The mic gain will set the level of microphone sensitivity for each headset.

4.8.1 Sidetone

Adjust the sidetone if necessary for good volume level using the VOX intercom. Ensure that the headset volume adjust is set to mid range, so the volume can be adjusted up/down by the user.

4.8.2 Mic Gain

Adjust the microphone gain if necessary for best audio “quality” not volume level. Use the VOX intercom operation to achieve best performance. The M760 P2 is fitted with separate mic gain trimpots to allow for adjustment of individual headsets.

4.8.3 Trimpot Adjustment

Punch the black dot carefully with a screwdriver blade, to expose the slotted plastic head of the trimpot, located approx 3mm (1/8”) below the surface of the casing. The second mic gain position is not marked, refer to the drawing below for location.

Note the position of the slot before making adjustments. Use a small flat bladed screwdriver to make small adjustments before testing with a headset again. The total movement of all trimpots is only 300 degrees (4/5th turn).

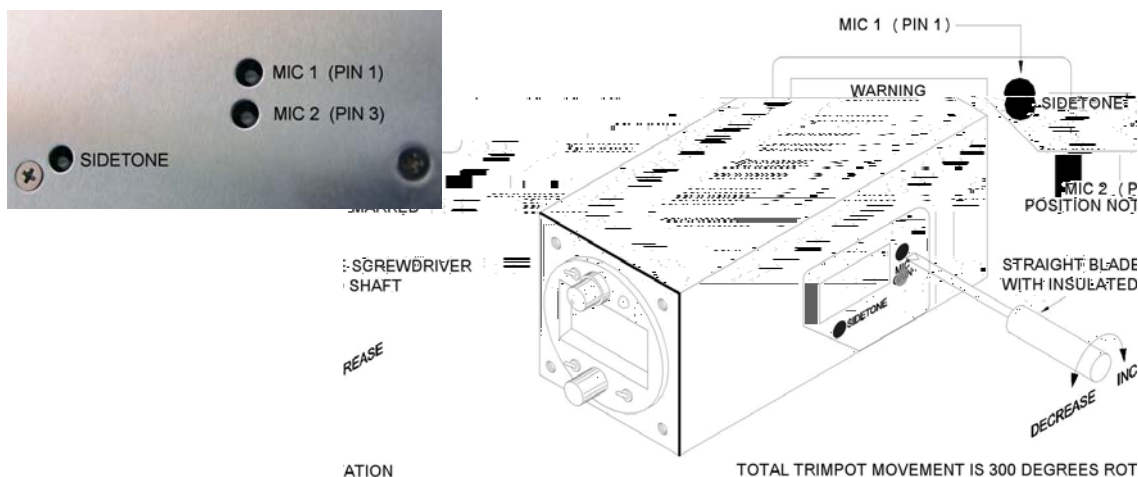

Do not attempt to adjust the modulation or power output. These adjustments can only be set correctly by a qualified technician. Adjustment of the power output or modulation by anyone other than Microair or their approved agent will void the warranty.

4.9 EXTERNAL INTERCOM

Where the M760 is to be installed with an external intercom, the internal VOX intercom should be disabled in the Program Mode Menu. See section 7.2.

Wire only a single mic line (pin 1), along with the PTT (pin 7), the headphone (pin 14), and a ground line (pin 11 or 12) to the intercom. Follow the intercom manufacturer's instructions for further installation.

Wire the remote memory line (pin 13), directly to the remote memory button location. This line is NEVER connected to the external intercom.

Refer to the Microair Avionics website www.microair.com.au for more details and wiring diagrams with commonly used intercoms.

4.10 DUAL COMM INSTALLATION

Where two M760's are to be installed in the aircraft, the interlock lines must be installed. Each interlock line shall be wired from (pin 4) on the first radio to (pin 7) on the second radio, and vice versa.

The interlock line allows the second radio to sense when the first radio is transmitting. In this situation the other radio deactivates its receiver to prevent any chance of damage to the second radio, or allow distortion noise to occur.

Refer to the Microair Avionics website www.microair.com.au for a full two comm wiring diagram.

Microair recommends the use of a rotary selector or multi-pole switch to switch the microphone and PTT lines from the first radio to the second. This selector should be clearly labelled.

5.0 OPERATIONAL CONTROLS



Front Face



Control Column

ITEM	CONTROL	DESCRIPTION
1	Priority Switch	Momentary push down switch
2	Volume / On / Squelch	Click On - Rotate knob for volume Rotate ring for squelch
3	Receiver / Transmit Annunciator	Red / Green LED
4	Mode Switch	Momentary push down switch
5	Frequency Adjust Knob	Rotate to adjust value Press to move cursor
6	Toggle Switch	Momentary push down switch
7	Remote Memory Button	Momentary push button
8	Push to talk (PTT) Button	Momentary push button

5.1 PRIORITY SWITCH

The priority switch is a push down switch. When pushed down *briefly*, the radio will go into channel mode, and select the frequency stored in memory 99. Memory 99 should be considered the *priority* channel, which the user can quickly select when required. Memory 99 must be programmed for the priority switch to operate. Memory 99 is set at the factory as the international distress frequency 121.500MHz. Memory 99 can be programmed the same way as any of the other channels, hence the factory default can be edited. Refer to section 7.5 to edit this memory.

The priority channel (memory 99) can not be deleted; it will default back to 121.500MHz – EMGY.

5.2 VOLUME / SQUELCH KNOB

The M760 is turned on, by rotating the volume knob. A positive “*click*” is heard and felt at the start of the rotation to indicate the on/off position. The volume is increased by rotating the knob clockwise, and decreased by rotating counter clockwise.

The squelch is adjusted by rotating the ring behind the volume knob. There is no automatic level set for the squelch, however the ring affords a large manual adjustment to suit all situations. Rotate the ring clockwise to increase the squelch threshold, and counter clockwise to lower the threshold. When the squelch is “*broken*” (ie the static hiss can be heard), the annunciator LED lights green.



Note: This does **NOT** mean you are receiving a signal!

5.3 ANNUNCIATOR LED

The LED operates red or green, and indicates the following states:

Clear (off)	Radio is squelched, and is not receiving a signal
Green	Squelch is broken or a signal is received
Red	Radio is transmitting
Flashing Red	Radio has transmitted for over 45 seconds (warning)

The flashing red signal is designed to draw the pilot’s attention to the fact that the aircraft may have a stuck PTT button!

Transmissions in excess of **30** seconds should be avoided.

While the M760 is in the program mode menu or memory programming mode the M760 is in its setup state. The radio can not transmit or receive while it is in the setup state.

5.4 MODE SWITCH

The mode switch is a push down switch, which will cycle through the operational modes of the **M760**. When pushed down *briefly* the radio will step to the next operating mode.

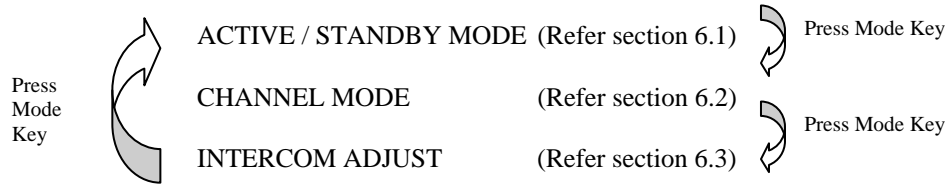

If the internal VOX intercom has been disabled in the program mode menu the intercom adjust mode will be skipped. See section 7.2 to enable / disable the internal VOX intercom.

5.5 FREQUENCY ADJUST KNOB

The frequency adjust knob is used to change display values and characters. Rotate the knob to scroll values or characters up or down. Press the frequency adjust knob inwards briefly to move the cursor to the next display item to adjust.

In the active/standby mode, only the standby frequency can be changed directly, the active frequency cannot be directly altered by the frequency adjust knob.

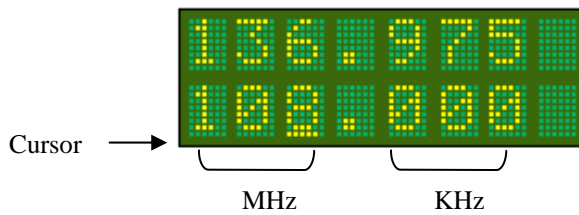

In channel mode the pilot can scroll alphabetically by turning the frequency adjust knob. Adjustment is restricted to the pre-programmed values stored in memory. Refer to section 7.5 for the input and amendment of channel memory database.

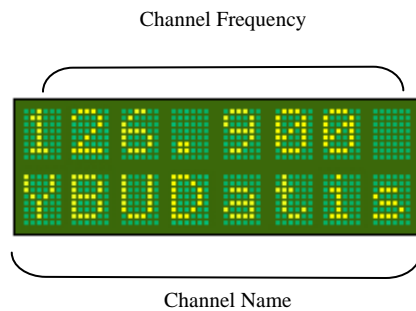

In VOX mode the threshold level can be adjusted up or down by turning the frequency adjust knob. Adjustment is restricted to values between 1 and 30.

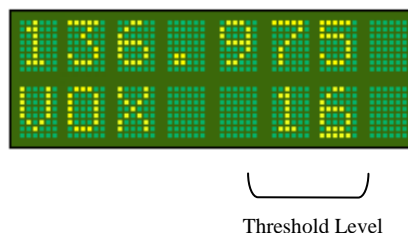

5.6 TOGGLE SWITCH

When the toggle key is pressed *briefly* in Active/Standby mode, the active and standby frequencies exchange places. Hold the toggle key down for 3 seconds to activate the monitor function.

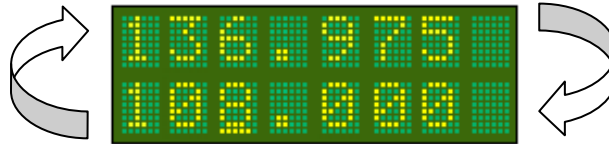

- When the M760 is in monitor mode, press the toggle key *briefly* to dis-engage the monitor function.
- When the M760 is in channel mode the toggle key is used to quick save the frequency.

The toggle key is also used in the **PROGRAM MODE** for programming functions.

5.7 REMOTE MEMORY BUTTON

If fitted at installation, the remote memory button will have the same functionality as the toggle button. It will allow the user to toggle (exchange) the active and standby frequencies. The remote memory button is typically mounted next to the PTT on the stick.



If the remote memory button is held down for 3 seconds while in the active / standby mode, the monitor function is activated. Refer to section 6.1.2 for complete details on monitor function.

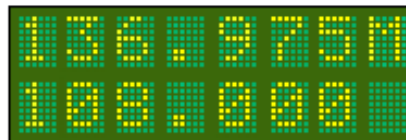

In channel mode, press the remote memory key *briefly* to cycle through the stored memory channels.

When the M760 is in VOX adjust mode, press the remote memory key *briefly* to increase the VOX threshold.



IMPORTANT NOTE

The remote memory button is highly recommended. It allows the user to be able to keep hands on the controls during flight, while changing channels or scanning.

5.8 PUSH TO TALK BUTTON

The push to talk (**PTT**) button causes the **M760** to transmit on the active frequency or selected memory channel. During transmission the LED annunciator will light **red** and the user will hear themselves speaking through their own headphones via the sidetone system.

The **M760** will *not* transmit if the active frequency or selected memory channel is below 118MHz.

The **M760** will *not* transmit if the CD lockout function is enabled and the M760 is currently receiving a signal. See section 6.1 to enable / disable the CD lockout function.

6.0 MODES

The M760 transceiver can operate in several operation modes. The user can step through these modes by pressing the mode key *briefly*. Operational modes are:

- Active/Standby Mode
- Channel Mode
- VOX Mode

6.1 ACTIVE/STANDBY MODE

The display shows the active or in use frequency on the top line. The standby frequency is displayed on the bottom line. Only signals on the active frequency are received. Transmissions can be made on the active frequency by pressing the **PTT** button.

The active and standby frequencies are swapped by pressing the remote memory button or the toggle switch. The standby frequency can be changed by scrolling the frequency adjust knob. The cursor can be moved between MHZ and KHZ positions by pressing the frequency adjust knob. Press the mode key to toggle the display from Active/Standby mode to Memory mode.



6.1.1 108 to 118 MHz

The pilot can select channels in the navigation (NAV) band from 108.000MHz to 117.975 MHz. The M760 will receive only on these channels – the PTT button is disabled.

Many civil aviation authorities are now allocating voice services such as ATIS in the NAV band.

6.1.2 Monitor Function

By holding down the remote memory button or toggle key for 3 seconds and then releasing, the **M760** will enable the monitor function. Both active and standby frequencies are monitored at the same time for a signal. An 'M' character will oscillate up and down to indicate that the monitor function is active.



A signal can be received on either the active or the standby frequency. While receiving a signal on the active frequency the standby channel is **NOT** monitored. While receiving a signal on the standby frequency the active channel is periodically monitored. If a signal is found on the active frequency the **M760** will revert to the active frequency. After a signal has been received the **M760** will return to monitoring both frequencies.



IMPORTANT NOTE

The user can only transmit on the active frequency. If the PTT is keyed the radio will transmit on the active frequency only.

Monitor mode can be cancelled by pressing the remote memory button or toggle key *briefly*. The 'M' character is no longer displayed at the right hand end of the display. If the mode key is pressed to move to channel mode, the monitor function is dis-engaged.



Monitor Mode
Monitoring on ACTIVE frequency



Monitor Mode
Monitoring on STANDBY frequency



Monitor Mode
Receiving on ACTIVE frequency



Monitor Mode
Receiving on STANDBY frequency



Monitor Mode
Transmitting on ACTIVE frequency



IMPORTANT NOTE

When active and standby channels are within 100KHz (4 channels), some interference may be heard when receiving on both frequencies at the same time. The interference is most prominent where there is a significant difference in signal strength between standby and active.

6.2 CHANNEL MODE

The M760 has memory database which can store up to 99 channels. Each channel can be programmed with any available frequency from 108.000 to 136.975MHz, and an 8 character channel name. Refer to the PROGRAM MODE Menu (sections 7.4 & 7.5) for details on the programming of memories.



When operating in channel mode, the programmed channels can be scrolled through alphabetically, by rotating the frequency adjust knob, or by pressing the remote memory button. Only programmed memories are displayed.

When changing operational modes the Active Frequency remains constant. When the operational mode is changed to channel mode the M760 will check all memory channels for the current active frequency. If it finds the current active frequency it will display the memory channel that corresponds to the current active frequency. If the current active frequency is not found in any memory channel a '?' will be displayed on the bottom line.

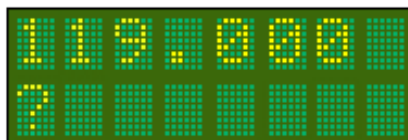

This active frequency can be quick saved in the next unused memory channel by pressing the toggle key. Any quick saved memory channels will appear at the end of the alphabetically sorted memory channels.

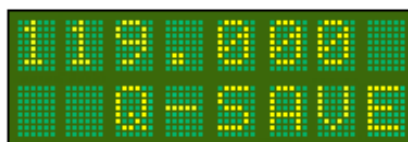

Factory setup defaults the first 5 memory channels to CH 01 through CH 05 for test purposes. The pilot is free to edit these channels to desired channel name and frequency.

6.3 VOX MODE

The M760 has a digitally controlled VOX intercom. The frequency adjust knob is used to adjust the VOX threshold.

When the VOX is adjusted to one the mic's will be on all of the time (hot mic). When the VOX is adjusted to 30 the mic's will require a very loud voice to activate.

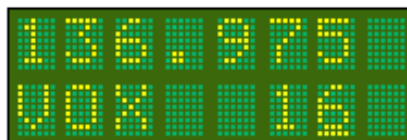

When in VOX mode the active frequency is displayed on the top line.

7.0 PROGRAMMING & SETUP

The **M760** can be started in program mode by holding the mode key down and turning on. The mode must be held down while the display goes through the start-up sequence, and ends with **PROGRAM MENU** on the display.



Rotate the frequency adjust knob to scroll through the **Program Mode Menu** items. Use the remote memory button or the toggle switch to select the menu item.

PROGRAM MODE MENU	MENU
	CD
	VOX
	MONITOR
	NEW MEM
	EDIT MEM
	EXIT

7.1 CD LOCKOUT

When **CD Lockout** is set **ON** the **M760** will not permit the **PTT** button to operate if a radio signal is currently being received. If the user attempts to transmit by keying the **PTT**, the **M760** will not transmit. The signal being received will be heard in the headphones or speaker.

When **CD Lockout** is set **OFF** the **M760** will permit the **PTT** to operate if a radio signal is currently being received.

Background:

In high traffic areas such as circuit patterns, there is often a high level of radio traffic. There is also a high instance of two aircraft trying to transmit at the same time. When this occurs the two transmissions interfere with each other, and neither call can be properly received.

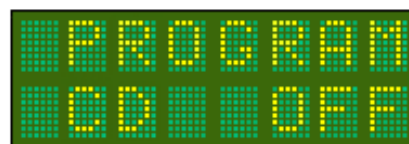
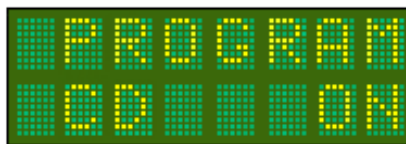

The **CD Lockout** is toggled by pressing the Toggle Switch. The factory default is to have the **CD lockout OFF**.

7.2 VOX

When **VOX** setup is set **ON** the **M760** the user is able to set the threshold of the internal VOX intercom via the intercom adjust screen. (See section 6.3)

When **VOX** setup is set **OFF** the **M760** will set the internal VOX intercom to its maximum threshold and disable the Intercom Adjust screen.

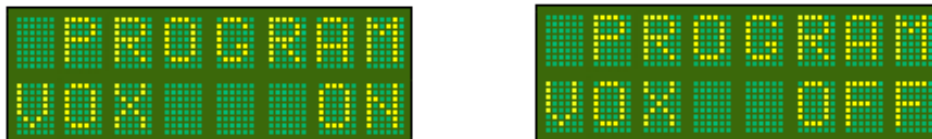

The **VOX** setup is toggled by pressing the Toggle Switch. The factory default is to have the internal VOX intercom ON.

7.3 MONITOR SETUP

MONITOR setup allows the user to adjust the interval of the monitor function.

Background:

Although the M760 only contains one receiver, it can monitor two frequencies at the same time. This is done by checking each frequency for just long enough to determine if there is a signal present. If no signal is present on the first frequency it can switch to the second frequency and check for a signal in the same manner.

When a signal is found the receiver is locked to that frequency. This is not a problem when the signal is received on the active frequency. However when a signal is received on the standby frequency the active frequency must still be monitored. This is achieved by periodically checking the active frequency for long enough to determine if there is a signal present. If no signal is found the receiver returns to the standby frequency.

During the check of the active frequency the standby frequency is not being received, this can be perceived as a short click. The M760 allows the interval between successive checks of the active frequency to be set by the pilot.

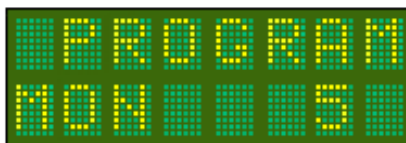

The **MONITOR** setup can be adjusted by pressing the Toggle Switch or the remote memory button. The adjustment is restricted to values between 1 and 9. The factory default is a interval of 5.

7.4 NEW MEMORY MODE

This option allows the user to program a new channel in memory. The frequency and channel name for the new memory channel can be set in this mode. This option will automatically select the next unused memory channel and start the memory programming process.

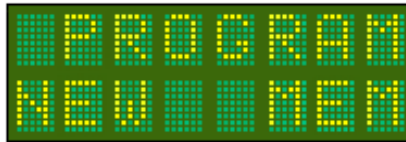

Using the frequency adjust knob set the frequency for the selected memory channel. The cursor can be cycled through the MHz and KHz by pressing the frequency adjust knob. Once the frequency is set press the remote memory button or the toggle switch *briefly*.



Cycle cursor between MHz, and KHz, by pressing the frequency adjust knob inwards briefly. Rotate the frequency adjust knob to change value.

Using the frequency adjust knob set the name for the selected memory channel. The cursor can be cycled through the character positions by pressing the frequency adjust knob. Once the name is set press the remote memory button or the toggle switch *briefly*.

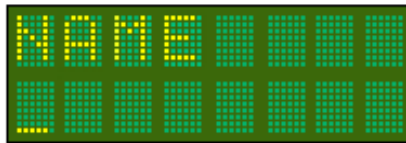

Cycle cursor between character positions, by pressing the frequency adjust knob inwards briefly. Rotate the frequency adjust knob to change the character.

The word **SAVED** appears on the bottom line. The M760 will then return to the **Program Mode Menu**.

7.5 EDIT MEMORY MODE

This option allows the user to program a channel in memory. The frequency and airport code stored in each memory channel can be set, changed, or cleared in this mode.

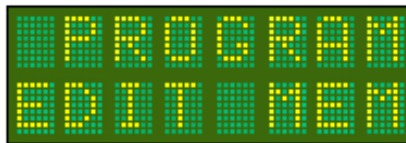

Using the frequency adjust knob select the memory channel to program. If the currently selected memory channel exists in memory the frequency and name are displayed. If the currently selected memory channel does not exist, only the memory channel number will be displayed in the top left corner of the display.

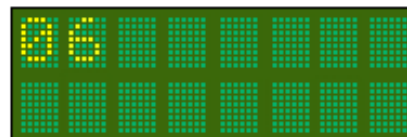

To create a new memory channel or edit an existing memory channel, scroll to the desired memory channel and press down the remote memory button or toggle switch *briefly*.

Using the frequency adjust knob set the frequency for the selected memory channel. The cursor can be cycled through the MHz and KHz by pressing the frequency adjust knob. Once the frequency is set press the remote memory button or the toggle switch *briefly*.



Cycle cursor between MHz, and KHz, by pressing the frequency adjust knob inwards briefly. Rotate the frequency adjust knob to change value.

Using the frequency adjust knob set the name for the selected memory channel. The cursor can be cycled through the character positions by pressing the frequency adjust knob. Once the name is set press the remote memory button or the toggle switch *briefly*. The word **SAVED** appears on the bottom line.

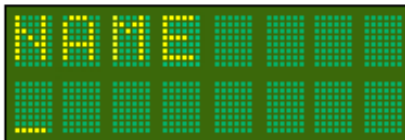

Cycle cursor between character positions, by pressing the frequency adjust knob inwards briefly. Rotate the frequency adjust knob to change the character.

The word **SAVED** appears on the bottom line. The M760 will then return to the **Program Mode Menu**.

To clear a memory, scroll to the desired memory channel and press down the priority switch *briefly*. The word **CLEARED** appears on the bottom line.

To return to the **Program Mode Menu**, press down the mode switch *briefly*.

Operating the priority switch in either Active/Standby mode, Channel mode, or VOX mode will move the M760 to memory 99. The user should consider carefully what frequency to program in memory 99. The factory default is the distress frequency 121.500MHz.

7.6 EXIT MENU

This option exits the **program mode menu** and causes the radio to sort the memory channels and step into Active/Standby Mode.

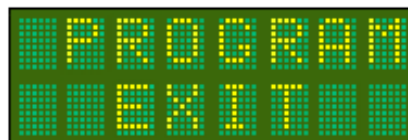

8.0 WIRING DIAGRAM

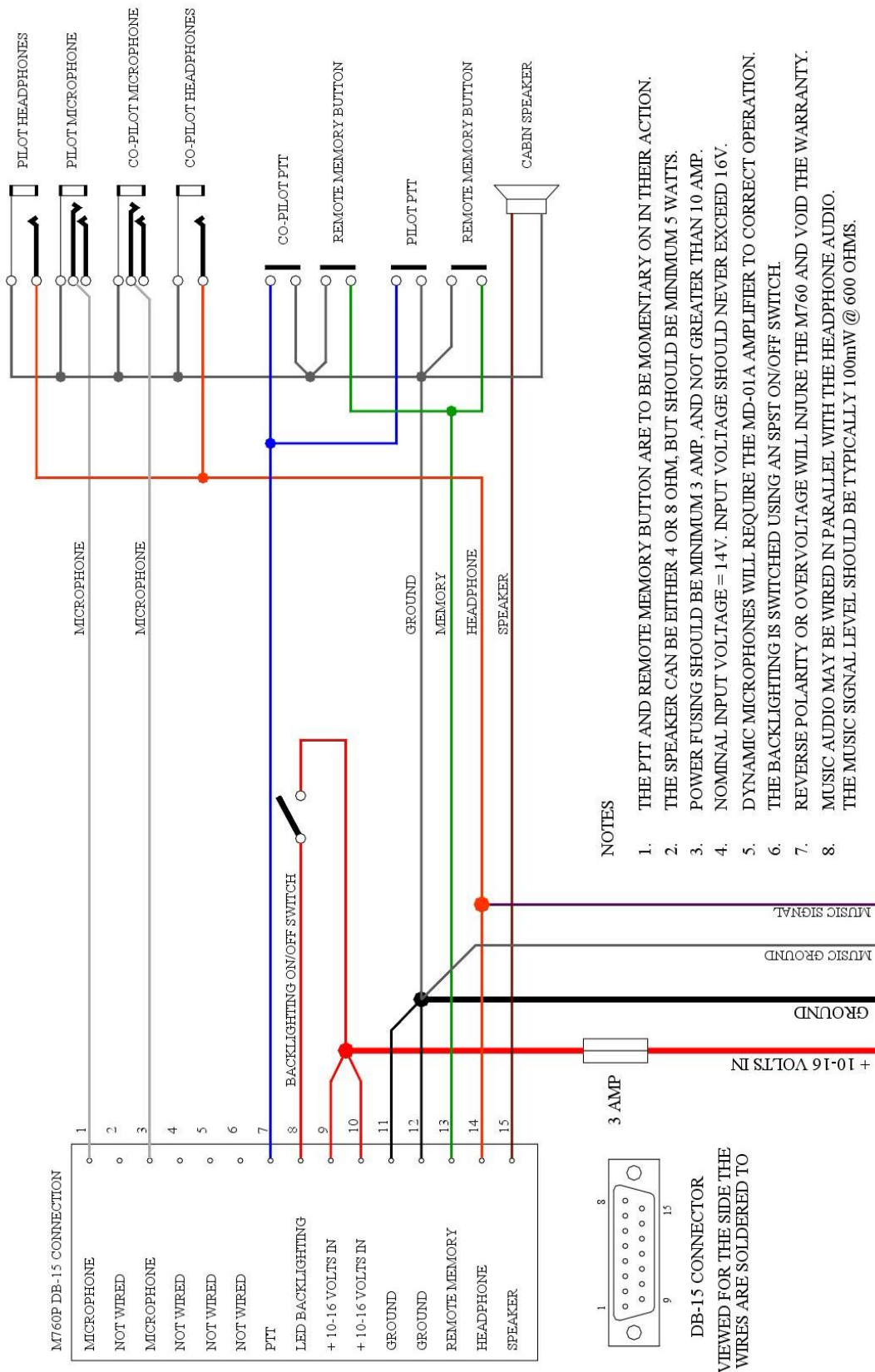

MICROAIR M760 (REV P) TRANSCIEVER
WIRING DIAGRAM
STANDARD INSTALLATION

9.0 SPECIFICATIONS M760P2

Radio Type	Amplitude Modulation (AM) Aircraft Transceiver
Channels (Transmit)	760 channels, 25KHz spacing 118.000 – 136.975MHz
Channels (Receive)	1160 channels, 25KHz spacing 108.000 – 136.975MHz
Frequency Selection	VFO dial
Frequency Display	2 line alpha/numeric LCD display (with backlighting)
Frequency control	PLL frequency synthesis, which is microprocessor controlled Memory is store in non-volatile EPROM
Memories	99 programmable memories
Dual Monitor	100ms Scan Time User selectable Scan Delay (0.7 seconds to 3.3 seconds)
Power consumption	Receive (no signal) 200 mA Transmit 1.8 A
Input Voltage	10 – 16 Volts Warning damage will occur above 16 Volts
Power output	5 watts (nominal)
VSWR Tolerance	< 5:1
Receiver sensitivity	12dB for > 1.0 uV 70% modulation (KHz audio)
Receiver Selectivity	-70dB
Squelch Threshold	0.5uV (full squelch range 0.5 - 8.0uV)
Speaker volume output	Nominal 4 watts output to 4 ohms
Headset volume output	Nominal 100milli-watts output to 600 ohms
Temperature range	-20 - +55 degrees Celsius
Stability	+/- 3.00ppm
Dimensions	W-65mm H-59mm D-135mm (plus 35mm for harness) W-2.6” H-2.3” D-5.3” (plus 1.5” for harness)
Exposed dial face	57mm diameter 2 ¼” diameter
Weight	400 grams 19.4 ounces

10.0 DRILLING TEMPLATE

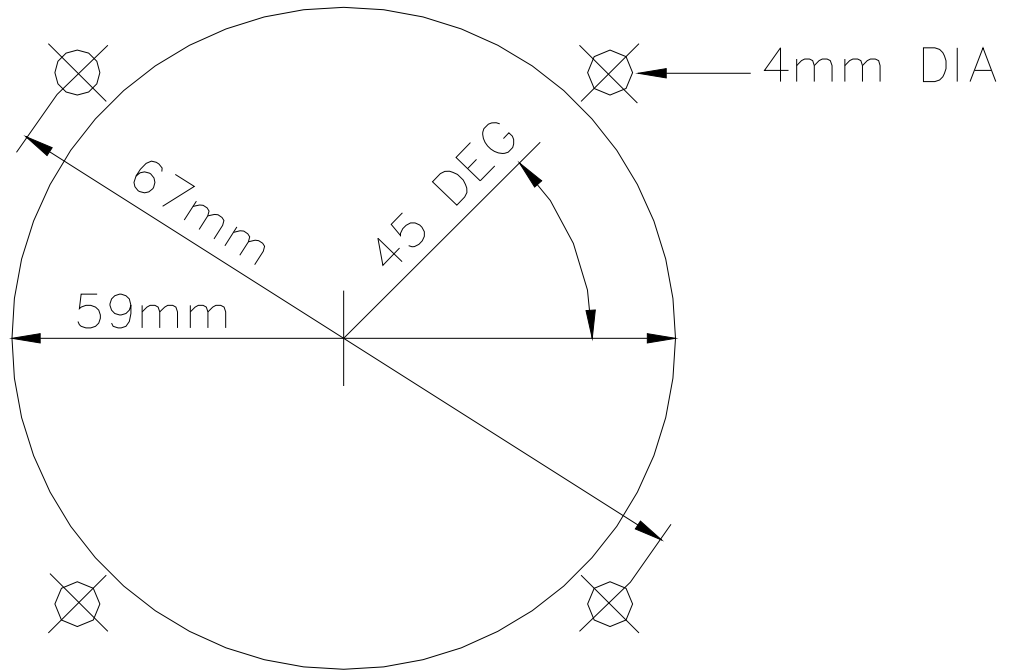

Drilling Template

11.0 LIMITED WARRANTY

11.1 LIMITED WARRANTY

The warranty period for any Microair Avionics manufactured article is dependant on Condition of the article at time of sale and the Purchase Date.

For **New Articles** the warranty period commences from Date of Purchase and is valid for 2 years or the minimum period defined by applicable consumer law, whichever is the longer.

In the absence of original Proof of Purchase the warranty will be valid for 2 years from Date of Factory Shipment as determined by Microair Avionics.

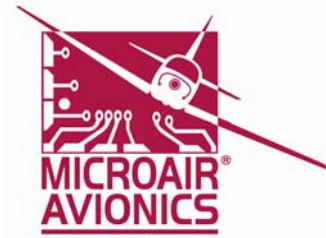

For **Factory Reconditioned Articles** offered for sale, the warranty period commences from Date of Purchase and is valid for 12 months.

For **Factory Exchanged Articles** the warranty period commences from the Date of Purchase of the original article and is valid for the remainder of the original warranty period.

For **Repaired Articles** the warranty period commences from the date of Factory Shipment and is valid for 6 months for the original defect only.

Microair Avionics will, at its sole discretion, repair or replace any components, which fail in normal use. Such repairs or replacement will be made at no charge to the customer for parts or labour. The customer shall be responsible for any transportation costs for return of this product to Microair Pty Ltd or an approved Microair Service Centre.

This warranty does not cover failures due to abuse, misuse, accident, unauthorised alteration, or repairs carried out by parties other than Microair Avionics or an approved Microair Avionics Service Centre. This warranty does not cover failures where the product has not been installed or operated, in accordance with the provisions of the User and Installation manual(s).

It shall be at Microair Avionics sole discretion to decide if a defect is a result of material or workmanship failure.

THE WARRANTIES AND REMEDIES CONTAINED HEREIN ARE EXCLUSIVE AND IN LIEU OF ALL OTHER WARRANTIES EXPRESSED OR IMPLIED, INCLUDING ANY LIABILITY ARISING UNDER WARRANTY OF MERCHANTABILITY OR FITNESS FOR A PARTICULAR PURPOSE, STATUARY OR OTHERWISE. THIS WARRANTY GIVES YOU SPECIFIC LEGAL RIGHTS, WHICH MAY VARY FROM STATE TO STATE, AND COUNTRY TO COUNTRY.

IN NO EVENT SHALL MICROAIR AVIONICS PTY LTD BE LIABLE FOR ANY INCIDENTAL, SPECIAL, INDIRECT OR CONSEQUENTIAL DAMAGES, WHETHER RESULTING FROM THE USE, MISUSE OR INABILITY TO USE THIS PRODUCT OR FROM DEFECTS IN THE PRODUCT.

Microair Avionics may at it discretion, refer product returns for repair or service, to a service facility closest to you. Microair Avionics reserves the right to repair or replace the product or software or offer a full refund of the purchase price at its sole discretion.

To obtain warranty service, please email or call the Microair Avionics Repair line in Australia.

Domestic or International Return instructions are available on our website. Please follow these instructions carefully.

Phone: ++ 61 7 4155 3048
Fax: ++ 61 7 4155 3049
Email: repair@microair.com.au
Website: www.microair.com.au

MAP 803 Microair Avionics Warranty Statement 01R3

Supplied by: